

MATRIX ANALYSIS OF STATICALLY AND KINEMATICALLY INDETERMINATE FRAMEWORKS

S. PELLEGRINO and C. R. CALLADINE

Department of Engineering, University of Cambridge, Cambridge CB2 1PZ, U.K.

(Received 10 September 1984; in revised form 11 April 1985)

Abstract—The paper is concerned with the structural mechanics of assemblies of bars and pin-joints, particularly where they are simultaneously statically and kinematically indeterminate. The physical significance of the four linear-algebraic vector subspaces of the equilibrium matrix is examined, and an algorithm is set up which determines the rank of the matrix and the bases for the four subspaces. In particular, this algorithm gives full details of any states of self-stress and modes of inextensional deformation which an assembly may possess. A scheme is devised for the segregation of inextensional modes into rigid-body modes (up to six of these may be allowed by the foundation constraints) and "internal" mechanisms. In some circumstances a state of self-stress may impart first-order stiffness to an inextensional mode. A matrix method for detecting this effect is devised, and it is shown that if there is no state of self-stress which imparts first-order stiffness to a given mode, then that mode can undergo rather large distortion which involves either zero change in length of the bars or, possibly, changes in length of third or higher order in the displacements. The significance of *negative* stiffness, as indicated by the matrix method, is discussed. The paper contains simple examples which illustrate all of the main points of the work.

LIST OF SYMBOLS

- A** equilibrium matrix
- A'** modified equilibrium matrix
- a, b** vectors
- B** kinematic matrix
- b** total number of bars
- C** kinematic matrix
- d** vector of joint displacements
- e** vector of bar elongations
- f** vector of joint forces
- I** identity matrix
- im** number of internal mechanisms
- J** number of joints excluding foundation joints
- j** total number of joints
- k** number of kinematic constraints on foundation joints
- m** number of inextensional mechanisms
- n** translation vector
- p** vector of product forces
- q** position-vector of joint *i*
- r** rank of matrix
- r** rotation vector
- rb** number of rigid-body motions
- s** number of states of self-stress
- t** vector of bar tensions
- u, v, w** components of displacement of joint
- u** displacement vector of joint *i*
- x, y, z** Cartesian coordinates

1. INTRODUCTION

The concepts of statical and kinematical determinacy are central to an understanding of the mechanics of pin-jointed frameworks of the type shown in Figs 1 and 2. The performance of a pin-jointed framework is a good guide to the performance of a real engineering structure having the same layout but with firmly connected joints [1-3]. These concepts are usually introduced to engineering students by means of an example such as that shown in Fig. 1(a). This frame is clearly statically determinate, since the tension in every bar can be determined by means of the equations of equilibrium for a given set of components of external force applied to the joint: the number of equations

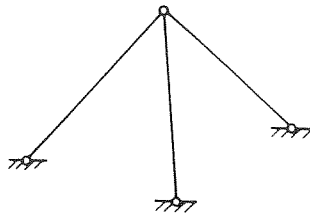

(a) $s = 0, m = 0$

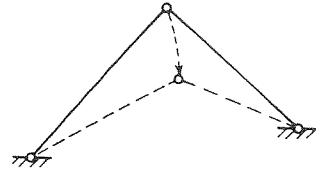

(b) $s = 0, m = 1$

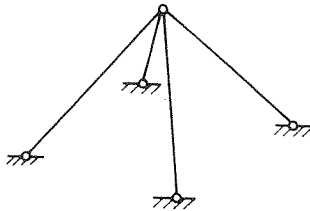

(c) $s = 1, m = 0$

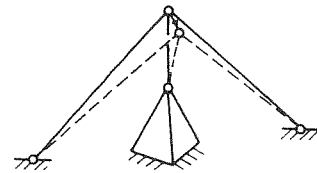

(d.1) $s = 1, m = 1$

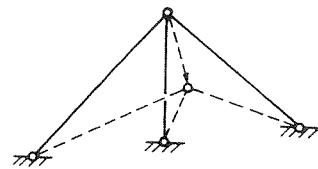

(d.2) $s = 1, m = 1$

Fig. 1. Perspective sketches of assemblies to illustrate statical and kinematical determinacy and indeterminacy. (a) The three foundation joints lie at the corners of a square. (b) One bar has now been removed, and the assembly has a mode of inextensional displacement in which the central node moves towards the reader. (c) The fourth bar makes the assembly statically indeterminate. (d.1) A third bar added to (b) makes the assembly both statically and kinematically indeterminate; but only small displacements of the inextensional mechanism are possible. (d.2) As (d.1), except that the three foundation joints are colinear, and free motion of the inextensional mechanism, as in (b), is possible.

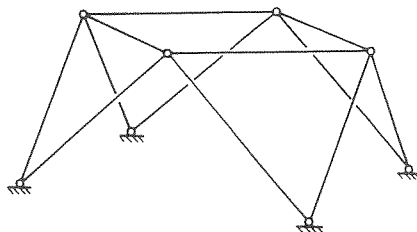

(a)

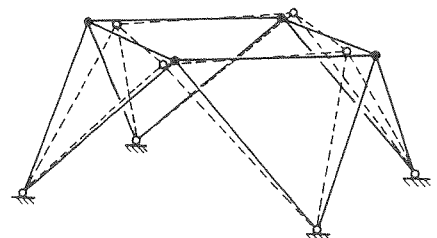

(b)

Fig. 2. (a) A ring assembly which satisfies Maxwell's rule, but (b) is statically and kinematically indeterminate with a free mechanism of inextensional displacement.

is equal to the number of unknowns, the coefficient matrix is nonsingular, and the solution is unique. This frame is also kinematically determinate in the sense that the position of the joint is uniquely determined (on one side of the plane of the base) by the lengths of the bars, as may readily be verified.

If now any one bar of the frame is removed, as in Fig. 1(b), the resulting assembly becomes a mechanism having one degree of freedom: it is *kinematically indeterminate*, since the location of the joint is not now uniquely determined by the length of the bars. The assembly has a *mode of inextensional deformation*, since it can distort without any change of length of the members.

But if an extra bar is added to the frame of Fig. 1(a), as shown in Fig. 1(c), the frame becomes *statically indeterminate*: there are now more unknowns than equations of equilibrium, and the solution for the set of bar tensions is not unique. Such a frame may be described as having a single redundant bar; but it is perhaps better to think of the indeterminacy in terms of a single *state of self-stress*, that is, a set of bar tensions which are in statical equilibrium with zero external force. In the present example it is clear that the last bar could be put into the assembly in a state of tension, and then the conditions of equilibrium would require other bars to be stressed also. It is easiest to visualise this by imagining that the new bar is a little shorter than the distance between the two joints which it is to connect, and that tension is necessary to provide the small elastic elongation which is required to make the bar fit.

An example of this type is usually supplemented, in undergraduate courses, by a formula known as Maxwell's rule, which is a necessary condition for both statical and kinematic determinacy in a framework. The three-dimensional version of this for frameworks which are adequately connected to a foundation (e.g. as in Figs 1 and 2) is

$$b = 3J, \quad (1)$$

where b is the total number of bars and J is the number of non-foundation joints.

This rule is based on the notion that the number of equations must be equal to the number of unknowns if the solution is to be unique[2].

A discussion along these lines of the general theory of structural frameworks may be adequate at an elementary level, but it has serious weaknesses in relation to more searching problems. Thus, it has been known for many years (e.g. [3]) that some frameworks satisfy Maxwell's rule and yet are kinematically indeterminate (see Figs 1(d) and 2). More recently it has been appreciated that such assemblies are also capable of self-stress, and moreover that in some circumstances a state of self-stress can impart some first-order stiffness to a mode of inextensional deformation[4, 5].

A more complete treatment of the linear-algebraic relationship between the numbers of equations and unknowns, which introduces the important idea of the *rank* r of the equilibrium matrix and its transpose, the kinematic matrix, leads to the expressions

$$s = b - r, \quad m = 3J - r, \quad (2)$$

and hence

$$s - m = b - 3J \quad (3)$$

as a replacement for (1) when all of the foundation joints (which are not counted in J) are pinned to the foundation: here s (≥ 0) is the number of independent states of self-stress and m (≥ 0) is the number of independent inextensional mechanisms.

The first step in the mechanical analysis of any given framework is the determination of the values of both s and m . If one of these can be found, eqn (3) immediately gives the other, since the values of b and J can be obtained by counting. But the determination of either s or m is not a trivial matter, in general; for, as Tarnai[6] has pointed out, the values of s and m depend not only on the numbers of bars and joints, nor even on the topology of the connections, but on the complete specification of the

Euclidean geometry of the assembly. Those who attempt to classify the mechanics of frameworks in terms of b and J alone end up in a state of confusion[7, 8].

For some specific frameworks it is possible to "spot" the value either of s or of m by physical intuition[5]. But it is clearly desirable to have a general algorithm for the direct computation of s and m from the geometrical data of any given framework. Such a scheme requires, of course, the determination of the rank of a matrix.

In this paper we describe briefly, but in sufficient detail, a computational scheme which not only determines the values of s and m in this way, but also computes the statical details of all of the states of self-stress and the kinematical details of all of the inextensional mechanisms. The method exploits in a simple way the standard linear-algebraic theory of vector spaces[9]: it turns out that all of the information which we require is contained in the *four fundamental vector subspaces associated with the equilibrium matrix*. An extension of the same ideas enables us to segregate the m mechanisms of a given assembly into the two classes of *rigid-body motions* and *internal mechanisms*: rigid-body motions occur when the assembly is less than fully restrained to a rigid foundation, up to a maximum of six for an assembly "free in space". For this purpose it will be necessary to introduce an extra parameter of foundation constraint into (2) and (3).

We also discuss the way in which a state of self-stress may, in general, impart some first-order stiffness to an inextensional mechanism, and we show how the calculation of this may be done. This feature is crucial to the action of pretensioned cable-nets, which may be described as self-stressed mechanisms having a large number of degrees of freedom[5, 10]; and in a forthcoming paper we shall extend our previous work to analyse their response to arbitrary loading.

It has been known for many years that there are, physically, two distinct kinds of inextensional mechanisms, which may be described as *infinitesimal* and *finite*, respectively. In a finite mechanism (e.g. Figs 1(b) and (d.2), Fig. 2) the joints can move freely for a finite distance with absolutely no change in the lengths of the bars. In an infinitesimal mechanism, on the other hand [e.g. Fig. 1(d.1)], there are, in general, some small changes in length of the bars when the joints move. These may be of second order in terms of the displacements or, in general, of third or higher orders. Infinitesimal inextensional mechanisms "tighten up" when mobilised, as in this example, in a way which depends quantitatively on the elastic properties of the bars.

A linear-algebraic analysis, which is set up only for the initial geometrical configuration, can detect inextensional mechanisms, but it cannot distinguish between these different types: in effect it can detect only the absence of *first-order* changes of length of the bars when the joints move.

Tarnai[6] has conjectured that it is only the *infinitesimal* inextensional mechanisms that can be stiffened by states of self-stress; and in another paper[11] he has listed among some problems for future research the following two questions.

1. What criterion determines whether self-stress stiffens an assembly which is both statically and kinematically indeterminate?
2. How can matrix methods be used to decide whether kinematical indeterminacy takes the form of an infinitesimal or a finite mechanism?

We concur with Tarnai's conjecture, and we give a physical explanation of it. Then we answer Tarnai's two questions by introducing a generalised equilibrium matrix and by setting out an algorithm which detects unambiguously which, if any, mechanisms are stiffened by a given state of self-stress. This algorithm, which is based on linear algebra, detects the presence of *first-order* stiffness in the self-stressed assembly. Therefore (as Koiter[12] has pointed out) it can only detect, in answer to Tarnai's second question, the presence of infinitesimal mechanisms which involve second-order changes of length, and which Tarnai (private communication) and Koiter[12] describe as "first order infinitesimal mechanisms".

Various points need to be mentioned before we begin our detailed analysis. First, we shall assume without further discussion that the idealisation of a physical framework or cable-net as a "pin-jointed assembly", loaded only at the joints, is appropriate. If

a member of the physical framework happens to be a wire—as in a cable-net—then the idealisation is only satisfactory, of course, as long as the wire is in a state of tension; and hence it is necessary to check in any given case that this is so. We shall also similarly disregard the possibility of buckling of thicker bars in compression.

Second, we shall work within the context of small-deflection theory when setting up the matrices from which the values of m and s are determined. That is, we shall set up the equilibrium equations for the loaded assembly in its original, undistorted configuration. This is, of course, a well-known procedure in structural mechanics which produces a set of linear-algebraic equations, and its limitations are well known. For assemblies having $m > 0$ the original configuration is not unique; but the equilibrium equations can still be set up in the given configuration. We have already noted the inexactness in the assessment of the changes in lengths of the bars which is inherent in a description of the kinematics of an assembly with reference only to the initial configuration.

2. LINEAR ALGEBRA OF PIN-JOINTED ASSEMBLIES

In this section we describe the equilibrium matrix and its transpose, the kinematic matrix, for a general pin-jointed framework; and we remark on the physical significance of the four *vector subspaces* which are well known in the linear-algebraic treatment of matrices.

Consider an assembly which consists of a total of j joints connected by b bars to each other and by a total of k kinematic constraints to a rigid foundation.

Two sets of statical variables must be considered: the *tensions* in the *bars* and the *external forces* applied to the *joints*. The tension in each bar is denoted by a single number, so there are altogether b *tensions*, assembled in the vector \mathbf{t} . Each unconstrained joint can be acted upon by an arbitrary force in three-dimensional Euclidean space, which we shall express as three independent scalar components. Joints which are held to the foundation with three, two or one kinematic constraints can transmit to the assembly zero, one or two components of external force, respectively: the *reactions* which are provided by the foundation play no part in the following analysis. We thus have a total of $3j - k$ components of external force, to which we shall refer as $3j - k$ *loads*, assembled in the vector \mathbf{f} .

Similarly, two sets of variables are needed to perform the kinematical analysis: the *elongations* of the *bars* and the *displacements* of the *joints*. Each of these corresponds directly to one of the statical variables, and we shall keep the same order of numbering for both sets. The components of joint displacement have precisely the same positive sense as the corresponding external loads. Thus, we have as kinematical variables: b *elongations*, assembled in the vector \mathbf{e} ; $3j - k$ *displacements*, assembled in the vector \mathbf{d} .

In setting up the equations in a Cartesian framework it is convenient to use a *tension coefficient*[2] instead of the tension proper for each bar, defined as tension/length. Then the corresponding measure of elongation of the bar is an *elongation coefficient*, defined as elongation \times length. We shall use the terms *tension*, *elongation* to include these convenient variants.

The three equilibrium equations for a general, unconstrained joint i , which is connected by bars l, m to two joints h, j , respectively [Fig. 3(a)], may be written in terms of tension coefficients:

$$\begin{aligned}(x_i - x_h)t_l + (x_i - x_j)t_m &= f_{ix}, \\ (y_i - y_h)t_l + (y_i - y_j)t_m &= f_{iy}, \\ (z_i - z_h)t_l + (z_i - z_j)t_m &= f_{iz}.\end{aligned}\tag{4}$$

Here (x_i, y_i, z_i) are the Cartesian coordinates of joint i in its original position, and $f_{ix,y,z}$ are the components of external force.

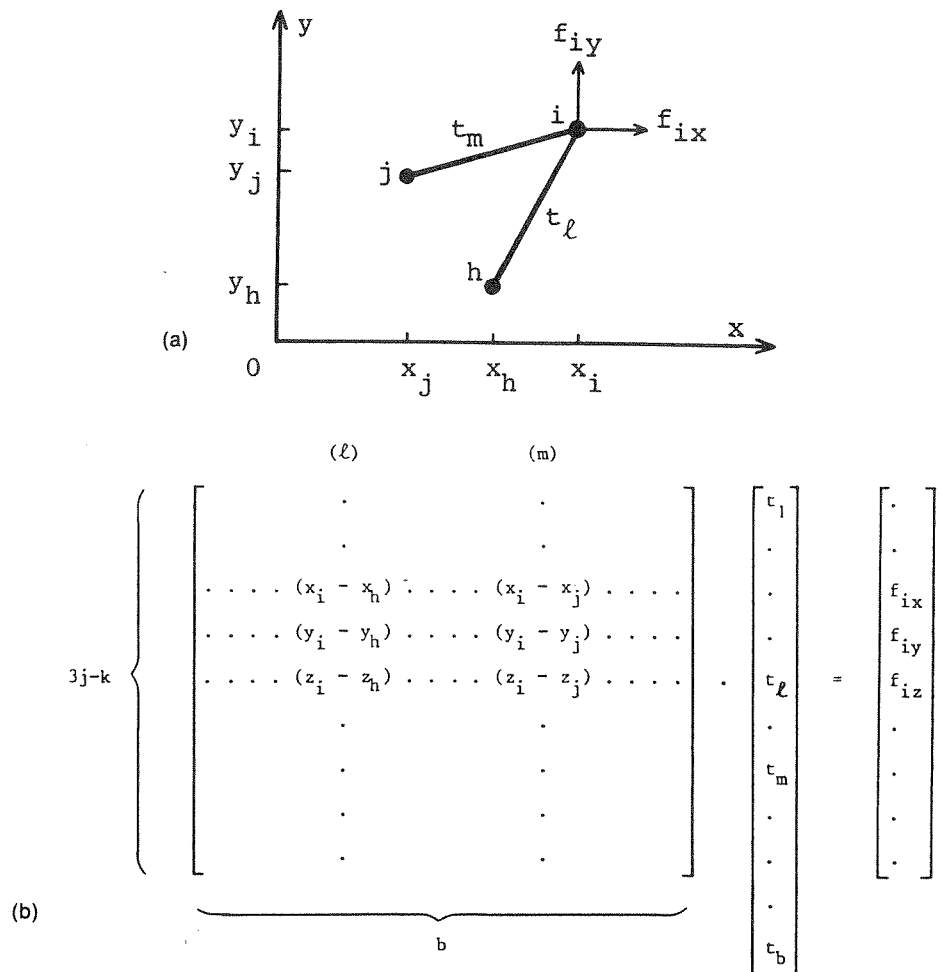

Fig. 3. (a) View along the axis Oz of a joint i which carries external forces and is connected by bars to joints h, j . (b) Assembly of equilibrium equations (4) in matrix form.

In this way the $3j - k$ equations of equilibrium in b unknowns can be written and assembled in matrix form as in Fig. 3. This may be written

$$\mathbf{A} \cdot \mathbf{t} = \mathbf{f}. \quad (5)$$

\mathbf{A} is the $(3j - k)$ by b equilibrium matrix.

The equations of kinematics of small displacements of the assembly may now be set up. For each bar there is one equation relating its elongation to the components of displacement of the joints at either end; and the resulting equations may be written

$$\mathbf{B} \cdot \mathbf{d} = \mathbf{e}. \quad (6)$$

\mathbf{B} is the b by $(3j - k)$ kinematic matrix.

It is straightforward to prove, by application of the principle of virtual work [4, 13], the general relationship

$$\mathbf{B} = \mathbf{A}^T. \quad (7)$$

The matrix \mathbf{A} is a linear operator between \mathbb{R}^b , the space of tensions and \mathbb{R}^{3j-k} , the space of loads. The theory of linear vector spaces indicates that four distinct vector subspaces are associated with matrix \mathbf{A} : see e.g. [9].

The names and dimensions of the four subspaces are as follows:

	Name	Dimension
bar space \mathbb{R}^b	(i) Rowspace of A	r_A
	(ii) Nullspace of A	s
joint space \mathbb{R}^{3j-k}	(iii) Column space of A	r_A
	(iv) Left nullspace of A	m

(8)

Equations (2) are now replaced by

$$s = b - r_A, \quad m = 3j - k - r_A, \quad (9)$$

and (3) is replaced by

$$s - m = b - 3j + k. \quad (10)$$

We shall indicate in Section 3 how the value of r_A (and hence of m , s) may be computed for a given matrix A, and how a *basis* may be determined for each of the four subspaces, i.e. a set of independent vectors which span the space. But first we shall describe the four subspaces in the order (iii), (iv), (ii), (i) in terms which are consonant with traditional textbook ideas in the theory of structures[2, 3]. We shall assume, for the sake of generality, that $s > 0$ and $m > 0$.

In the following description we shall, for the sake of simplicity, consider as two separate load conditions the (unique) projections of a given arbitrary load condition onto the column space and the left nullspace of A, respectively. In this way we shall consider only load conditions which lie in one or the other of the two orthogonal subspaces. Similarly, we shall refer separately to the projections of an arbitrary joint-displacement condition onto the same two subspaces; and we shall also treat in a similar manner sets of tensions and elongations only in terms of their projections onto the row space and the nullspace of A, respectively.

The column space of A. (iii) is the space spanned by the columns of A. By (5) this gives the range of the load vector \mathbf{f} which can be supported in statical equilibrium by the assembly in its original geometry. There are r_A *independent* columns of A, and we may use these as the basis of the column space of A, which thus has dimension r_A . Physically each of these r_A columns corresponds to a particular bar in the assembly. The other $b - r_A = s$ bars are *redundant*, and if they are removed (or otherwise rendered incapable of sustaining tension) the non-redundant bars form a statically determinate assembly; i.e. the tension coefficients are determined uniquely by the equilibrium equations when a permissible external load vector is applied.

Since $\mathbf{B} = \mathbf{A}^T$, there is also a kinematic interpretation of this subspace. The column space of A includes all possible modes of displacement of the assembly which require the elongation of one or more bars, i.e. all modes of deformation which are *not inextensional mechanisms*. This may be deduced directly from the statical description given above, by application of the principle of virtual work.

The left nullspace of A. (iv) represents the range of loads \mathbf{f} which, in contrast to the range described above, cannot be carried by the assembly in its original configuration. Its dimension is $3j - k - r_A = m$. It is important to realise that these forbidden components of load are related to the inextensional mechanisms of the assembly, which they would "excite". And indeed, in kinematic terms the left nullspace of A is precisely the space spanned by the m independent inextensional mechanisms of the assembly. Following Vilnay (private communication) we shall refer to the load vectors in the column space of A as *fitted loads*: they are "fitted" in the sense that they "balance" and do not "excite" any of the m mechanisms.

The left nullspace is in fact the *orthogonal complement* of the column space of A. This is indicated schematically on the right of Fig. 4. There are altogether $3j - k$

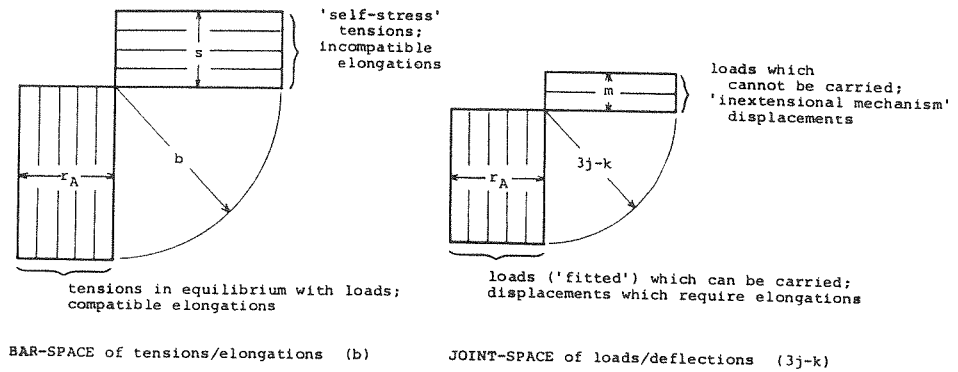

Fig. 4. The four fundamental subspaces of matrix A [cf. (9)]. The basis of the load/deflection space involves $3j - k$ vectors each containing $3j - k$ elements but divided into two orthogonal subspaces containing r_A and m vectors, respectively. The vectors of the orthogonal subspaces are drawn orthogonal. (The legends refer to the projections of arbitrary load conditions, etc. onto the respective subspaces.)

elements. The basis of the column space occupies r_A of these, while the remaining m form the basis of the left nullspace. The diagram is drawn to suggest the orthogonality which comes directly from the linear algebra: every vector in the left nullspace is orthogonal to every vector in the column space. Thus, every forbidden load condition is orthogonal to each fitted load, and every inextensional mechanism is orthogonal to each extensional mode.

The row space of A . (i) represents the bar-tension vectors which are in equilibrium with the fitted loads, occupying the column space of A . It has dimension r_A . For any fitted load carried by the assembly without self-stress, the vector of bar-tensions is a linear combination of the base vectors of this space. The kinematic interpretation of this subspace is straightforward: the subspace is filled by all r_A independent sets of bar elongations which are geometrically compatible.

The nullspace of A . (ii) represents all states of tension in the assembly which are in equilibrium with zero load, i.e. all states of self-stress of the assembly. The dimension of this subspace is $b - r_A = s$. The s states of self-stress are orthogonal to all vectors in the row space of A , as shown schematically on the left of Fig. 4. The kinematical interpretation of this subspace is that it contains all combinations of bar elongations which are forbidden by the conditions of geometrical compatibility of the assembly. (Compare to the left nullspace of A , which combines all states of loading which are forbidden by the equations of equilibrium.) These forbidden sets of bar elongations are orthogonal to all of the geometrically compatible sets of elongations.

The diagrams of Fig. 4 are adaptations of Fig. 27 of [9]. Here, however, we have not sought to describe the mapping between the bar space and the joint space, apart from the relationships implied in the verbal descriptions of the subspaces. We should perhaps emphasise here that there is no unique basis for any of the four subspaces: any linear combination of the linearly independent base vectors will constitute an equally valid alternative basis.

Lastly, we should remark that the only ingredients in the present treatment of the vector spaces have been the equations of equilibrium and kinematics of the assembly; that is, the equations of statical equilibrium of the assembly in its original geometry on the one hand, and the equations of the kinematics of small displacements of the assembly from its original shape on the other. In particular, we have not considered so far any possible relationship between the tension in a bar and its elongation in accordance with, for example, the elasticity of the material of which the bars are made; and neither have we considered what happens to the equations of equilibrium if the geometrical configuration of the assembly changes perceptibly from its original state either by excitation of one or more of the m inextensional mechanisms, or by any elongations, elastic or otherwise, of the bars.

3. A SCHEME OF COMPUTATION

We now describe an algorithm for the automatic computation of the value of r_A (and hence, by (9), of m, s) and of bases for the four fundamental subspaces of A .

First we write out the matrix A with an adjoining identity matrix I of dimension $3j - k$, as shown in Fig. 5(a). We then proceed to operate on the rows of the extended matrix $A | I$ with the aim of transforming A into a "staircase pattern" or echelon form with zeros in the lower-left triangle, as shown schematically in Fig. 5(b) (cf. [9]). The transformation is performed by a modified Gaussian elimination. The matrix I associated with A is sometimes known as the record matrix, since it records precisely the row operations performed during the elimination.

In the first stage of the transformation the aim is to have a nonzero entry in position (1,1) with zeros in the remainder of the column. In the operations leading to this we exchange row 1 of $A | I$ with the row that contains the largest entry in column 1, and we use this as the pivotal row to transform the rows below it. Next we perform similar operations on the matrix obtained by disregarding the first row and the first column, with the aid of securing a nonzero entry at (2,2) and zeros in the lower part of the second column, as shown in Fig. 5(b).

Now while these operations are being carried out, it sometimes happens that no pivot can be found in the column under investigation, in which case we transfer attention successively one column to the right, until a pivot is eventually found or column b has been processed.

When the process has been completed, the bottom $m = 3j - k - r_A$ rows of A are filled by zeros. Thus, in the transformed matrix $\tilde{A} | \tilde{I}$ shown schematically in Fig. 5(b), pivots were found in columns 1, 2 and 5, but not in columns 3, 4, 6 and 7.

The columns with pivots are marked * in Fig. 5, and these denote in fact r_A linearly independent columns of the original matrix, which are also marked * after the transformation is complete. The elements of the vector t which correspond to columns not marked * are the redundant bars.

Since all nontrivial applications of the method described above require the use of a digital computer to assemble $A | I$ and transform it into $\tilde{A} | \tilde{I}$, the entries of these matrices will be expressed as floating-point numbers. How many digits are stored at any time depends on the particular computer we use: in any case small errors creep in at each step of the calculation. Modern numerical analysis[14] makes available a variety of techniques to prevent the buildup of unacceptable errors and improve therefore the numerical stability of a large-scale computation. In the Appendix we give a schematic flowchart of our elimination subroutine: this scheme has been extensively tested on an IBM 3081. (For these tests the smallest acceptable number was 10^{-4} .)

Only a little more effort is now required in order to obtain bases for the four subspaces described above.

Column space of A. The r_A columns of A marked * form a basis for this subspace.

Left nullspace of A. The bottom $m (= 3j - k - r_A)$ rows of \tilde{I} form a basis for this space. This follows from the fact that the equations $\tilde{A} \cdot t = \tilde{I} \cdot f$ are precisely equiv-

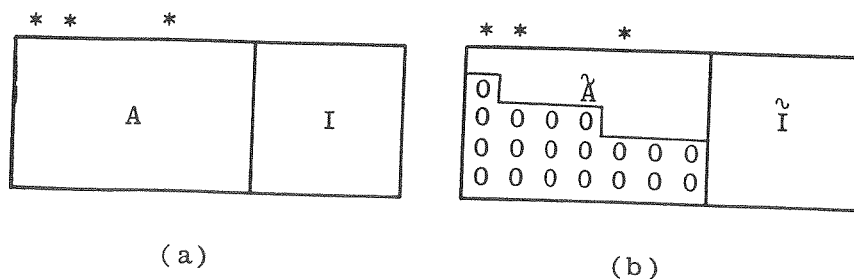

Fig. 5. Diagram to show the way that the equilibrium matrix A together with the unit matrix I is transformed by row operations into the echelon form $\tilde{A} | \tilde{I}$. Pivots are found in columns 1, 2 and 5.

alent to the original eqns (5), and the bottom m rows then state that each of the bottom m rows of $\bar{\mathbf{I}}$ is orthogonal to \mathbf{f} .

Row space of A. The upper r_A rows of $\bar{\mathbf{A}}$ form a basis for this space.

Nullspace of A. A basis for this subspace is found in the following way. Consider $\bar{\mathbf{A}} \cdot \mathbf{t} = 0$. Put $t = 1$ for the first redundant bar, and solve (uniquely) for the tensions in the non-redundant bars. The vector \mathbf{t} so obtained is a base vector of this nullspace. The other $s - 1$ base vectors are obtained similarly by having $t = 1$ for each of the redundant bars in turn. Since the equations $\mathbf{A} \cdot \mathbf{t} = \mathbf{f}$, $\bar{\mathbf{A}} \cdot \mathbf{t} = \bar{\mathbf{I}} \cdot \mathbf{f}$ are equivalent, solutions of $\bar{\mathbf{A}} \cdot \mathbf{t} = 0$ give the s independent states of self-stress of the assembly.

4. AN EXAMPLE

Figure 6 shows an assembly of three equal bars, I, II, III, each of length 1 and connected in-line to a rigid foundation at nodes C, D. We shall regard this assembly as lying in a plane: consequently, in the expressions above, $3j - k$ is replaced by $2j - k$. Here we have $b = 3$, $2j - k = 8 - 4 = 4$; $k = 2 \times 2 = 4$, since joints C and D are fully constrained in the plane. The four components of external force/displacement are labelled 1-4 on the diagram.

By inspection, the equilibrium equation

$$\mathbf{A} \cdot \mathbf{t} = \mathbf{f}$$

is given by

$$\begin{bmatrix} 1 & -1 & 0 \\ 0 & 0 & 0 \\ 0 & 1 & -1 \\ 0 & 0 & 0 \end{bmatrix} \cdot \begin{bmatrix} t_I \\ t_{II} \\ t_{III} \end{bmatrix} = \begin{bmatrix} f_1 \\ f_2 \\ f_3 \\ f_4 \end{bmatrix}. \quad (11)$$

Thus

$$\mathbf{A} | \mathbf{I} = \begin{bmatrix} 1 & -1 & 0 & | & 1 & 0 & 0 & 0 \\ 0 & 0 & 0 & | & 0 & 1 & 0 & 0 \\ 0 & 1 & -1 & | & 0 & 0 & 1 & 0 \\ 0 & 0 & 0 & | & 0 & 0 & 0 & 1 \end{bmatrix}, \quad (12)$$

and by following the procedure described above [which here involves merely the replacement of row 2 by $1 \cdot (\text{row } 3) - 0 \cdot (\text{row } 2)$ and of row 3 by $1 \cdot (\text{row } 2) - 0 \cdot (\text{row } 3)$], we obtain

$$\bar{\mathbf{A}} | \bar{\mathbf{I}} = \begin{bmatrix} 1 & -1 & 0 & | & 1 & 0 & 0 & 0 \\ 0 & 1 & -1 & | & 0 & 0 & 1 & 0 \\ \hline 0 & 0 & 0 & | & 0 & 1 & 0 & 0 \\ 0 & 0 & 0 & | & 0 & 0 & 0 & 1 \end{bmatrix}. \quad (13)$$

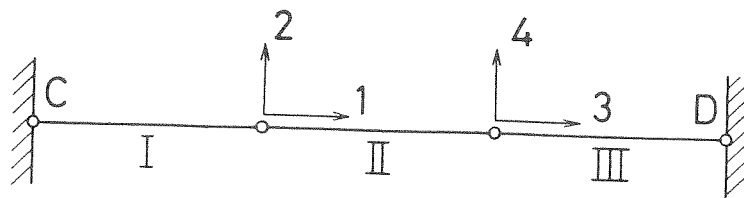

Fig. 6. An assembly of bars and joints in a plane.

Clearly $r_A = 2$, and so, by (9) $s = 1, m = 2$. Bar III is the redundant bar. The nullspace of A —i.e. the 1 state of self-stress—is obtained by back-substitution from

$$\begin{bmatrix} 1 & -1 & 0 \\ 0 & 1 & -1 \\ 0 & 0 & 0 \\ 0 & 0 & 0 \end{bmatrix} \cdot \begin{bmatrix} t_I \\ t_{II} \\ 1 \end{bmatrix} = \begin{bmatrix} 0 \\ 0 \\ 0 \\ 0 \end{bmatrix}, \tag{14}$$

so

$$\begin{bmatrix} t_I \\ t_{II} \\ t_{III} \end{bmatrix} = \begin{bmatrix} 1 \\ 1 \\ 1 \end{bmatrix}. \tag{15}$$

The other three subspaces are found exactly as described above and are displayed in Fig. 7 (cf. Fig. 4).

All of the various features pointed out in Fig. 4 may be verified by inspection, and the *orthogonality* of the respective subspaces may be checked directly.

$$\underbrace{\begin{bmatrix} 1 & 0 \\ -1 & 1 \\ 0 & -1 \end{bmatrix}}_{r_A=2} \begin{bmatrix} 1 & 1 & 1 \end{bmatrix} \quad s = 1 \qquad \underbrace{\begin{bmatrix} 1 & -1 \\ 0 & 0 \\ 0 & 1 \\ 0 & 0 \end{bmatrix}}_{r_A=2} \left. \begin{bmatrix} 0 & 1 & 0 & 0 \\ 0 & 0 & 0 & 1 \end{bmatrix} \right\} m = 2$$

bar-space (3) joint-space (4)

Fig. 7. As Fig. 4, for the specific example of Fig. 6.

5. FURTHER ANALYSIS

The preceding description of the four fundamental vector subspaces of a general pin-jointed assembly, and a scheme for their evaluation in a given case are, we claim, an essential preliminary to a complete understanding of the mechanics of such assemblies.

We have related each of the subspaces to well-known textbook ideas in the theory of structures, but our scheme is actually something more than a compendium of existing ideas. For example, in an assembly having a single redundant bar, $s = 1$, the usual textbook approach is to seek a *single* condition of geometrical compatibility by using the known set of bar tensions in the state of self-stress, together with the principle of virtual work. Here, in contrast, we display (e.g. Fig. 4) *all* independent sets of compatible bar elongations—each of which is, of course, orthogonal to the state of self-stress. But the main advantage of generating, in the course of standard computation, a full basis for each of the subspaces will be seen in Section 7, where we shall need to know the rank of a new matrix composed in part of the column space of A .

The example in the preceding section was chosen so that $m > 0$ and $s > 0$. It might be argued that for two of the four possible classes of assembly (see Fig. 1) in which $m = 0$, the usual methods of structural analysis of statically determinate and indeterminate assemblies are fully adequate, and hence that the vector-space approach is unnecessary. We shall demonstrate below, however, that our approach enables us to answer for the first time Tarnai's questions (Section 1) concerning the mechanics of assemblies having $m > 0$ (whether $s = 0$ or $s > 0$); but in any case we believe that the

conceptual and computational scheme symbolised by Fig. 4 is advantageous in discussion of the mechanics of pin-jointed assemblies in general.

Some of the techniques of linear algebra presented above are not entirely new in the context of structural analysis. Thus, the transformation of the equilibrium matrix into an echelon form is a generalisation of the "rank technique" method proposed by Robinson[15]. Przemieniecki[16] and McGuire and Gallagher[17] devote sections of their textbooks to the automatic assessment of kinematical indeterminacy. But only Livesley[18] introduces a record matrix in his computational scheme in order to evaluate automatically a mechanism of plastic collapse of a redundant frame. Buchholdt, Davies and Hussey[19] were the first to give a general formula corresponding to (3), but they did not pursue linear algebra beyond this point. Crapo[20], of the Research Group on Structural Topology, has many points in common with the present work. He discusses the same vector subspaces, but goes on to take a projective-geometric view, whereas we have decided to compute in detail the bases of these subspaces. Other workers in the same group[21, 22] have proposed general criteria for the rigidity of particular classes of pin-jointed assemblies in n -dimensional space.

6. RIGID-BODY MECHANISMS

The scheme described above gives, in particular, m independent inextensional mechanisms of the assembly spanning the left nullspace of A . In the case where the assembly is unattached to a rigid foundation, these will obviously include six independent inextensional motions of the assembly as a rigid body in three-dimensional Euclidean space, in addition to any internal inextensional mechanisms which the assembly may possess. It is clear that the procedure described above does not make this distinction, and that an efficient algorithm is needed to segregate the rigid-body mechanisms from the others. The following scheme does this; and it can cope with assemblies having any number between zero and six of rigid-body motions.

Consider the previous general pin-jointed assembly, having a total of k kinematic constraints to a rigid foundation, and let the locations of the joints in the original configuration be described with respect to fixed Cartesian coordinates $0xyz$. Any rigid-body displacement of the assembly may be described by translation and rotation vectors

$$\mathbf{n}_0 = (n_{0x}, n_{0y}, n_{0z}), \quad \mathbf{r} = (r_x, r_y, r_z). \quad (16)$$

Here \mathbf{n}_0 represents the displacement of that point of the assembly which lies at the origin of the coordinates in the original configuration; \mathbf{r} is the rotation about this point. In such a rigid-body motion the displacement of a point i having position vector \mathbf{q} in the original configuration is given by

$$\mathbf{u}_i = \mathbf{n}_0 + \mathbf{r} \times \mathbf{q}. \quad (17)$$

Now if i is a joint of the assembly which is fully restrained to the foundation, the three kinematic conditions

$$u_i = v_i = w_i = 0 \quad (18)$$

are imposed on any rigid-body motion; and thus (18) gives three scalar equations:

$$\begin{aligned} n_{0x} &+ z_i r_y - y_i r_z = 0, \\ n_{0y} &- z_i r_x + x_i r_z = 0, \\ n_{0z} &+ y_i r_x - x_i r_y = 0. \end{aligned} \quad (19)$$

If this joint had only two or one degrees of kinematic constraint, then two or one of the above three relations, respectively, would apply. Each of the external restraints imposes one condition on \mathbf{n}_0 and \mathbf{r} ; and hence the k external constraints together give a

system of k equations in six unknowns:

$$[C] \cdot \begin{bmatrix} \mathbf{n} \\ \mathbf{r} \end{bmatrix} = [0]. \quad (20)$$

C is a k by 6 kinematic matrix. The rank r_C of this matrix counts how many of the k external constraints effectively suppress rigid-body degrees of freedom of the assembly. This rank can be determined by the procedure described earlier in relation to the matrix A .

Thus we may obtain the number, rb , of rigid-body motions:

$$rb = 6 - r_C. \quad (21)$$

The procedure also provides a basis for the subspace of these rigid-body motions in terms of the six scalar components of \mathbf{n}_0 , \mathbf{r} , and these may be used in (17) to obtain an expression for these rigid-body mechanisms in terms of the components of displacement of each joint of the assembly.

Having determined the rb rigid-body motions in this way, we now require to find a basis for the im -dimensional space of *internal* mechanisms of the assembly:

$$im = m - rb. \quad (22)$$

First we orthogonalise the m intextensional mechanisms already found in Section 3, say $\mathbf{a}_1, \dots, \mathbf{a}_m$ (i.e. the left nullspace of A) to the rb rigid-body mechanisms, which themselves have also been orthogonalised, say $\mathbf{b}_1, \dots, \mathbf{b}_{rb}$ by use of the formula

$$\mathbf{a}_i = \mathbf{a}_i - \frac{\mathbf{a}_i \cdot \mathbf{b}_j}{\|\mathbf{b}_j\|^2} \cdot \mathbf{b}_j, \quad j = 1, \dots, rb. \quad (23)$$

This operation transforms the original mechanisms into a set of m internal mechanisms. We know that only im of these are linearly independent; and we can use modified Gaussian elimination, as in Section 3, to detect which columns of the $(3j - k)$ by m matrix $(\mathbf{a}_1, \dots, \mathbf{a}_m)$ are dependent on the others. These are then suppressed, and the remainder form the required basis for the space of internal inextensional mechanisms of the assembly.

7. STIFFENING EFFECTS OF SELF-STRESS

So far we have been concerned only with the separate equations of equilibrium and kinematics of small deflections of an assembly in its original geometry. Let us investigate further an assembly with $s > 0$ and $m > 0$; and, for reasons which will become clear later, let us consider only the im internal inextensional mechanisms. First let us give the assembly a state of self-stress, and then let us impose a small amplitude of one or more of the internal inextensional mechanisms.

In its original configuration, of course, the assembly is in equilibrium under zero external load. But when the geometry is altered slightly this will no longer be true, in general, since the coefficients of (5) will have changed slightly; and indeed it has already been shown[4, 5] that in some relatively simple examples a state of prestress can stiffen one or more inextensional mechanisms.

The key to the situation is the evaluation of the so-called product-force vector[10] associated with any given mechanism in an assembly which sustains a given state of self-stress. For this purpose we consider that the state of self-stress in the assembly does not change when the mode of inextensional displacement is excited: certainly the self-stress need not change in an assembly of elastic bars since—to first order, at least—the lengths of the bars do not alter during the deformation.

Rewriting the equilibrium eqns (4) for an infinitesimally displaced configuration,

we have

$$\begin{aligned}
 [(x_i + u_i) - (x_h + u_h)] t_l + [(x_i + u_i) - (x_j + u_j)] t_m &= f_{ix}, \\
 [(y_i + v_i) - (y_h + v_h)] t_l + [(y_i + v_i) - (y_j + v_j)] t_m &= f_{iy}, \\
 [(z_i + w_i) - (z_h + w_h)] t_l + [(z_i + w_i) - (z_j + w_j)] t_m &= f_{iz},
 \end{aligned}
 \tag{24}$$

where u_i, v_i, w_i, \dots are the components of displacement of joint i, \dots according to the inextensional mechanism considered, and t_l, \dots are now understood to denote a state of self-stress. Subtraction of eqns (4), written in the original configuration, from eqns (24) gives the expressions for calculation of the product forces:

$$\begin{aligned}
 p_{ix} &= (u_i - u_h) t_l + (u_i - u_j) t_m, \\
 p_{iy} &= (v_i - v_h) t_l + (v_i - v_j) t_m, \\
 p_{iz} &= (w_i - w_h) t_l + (w_i - w_j) t_m.
 \end{aligned}
 \tag{25}$$

Equations of this type can be used for each unconstrained component of joint displacement and for each internal mechanism to assemble a set of im vectors of dimension $3j - k$:

$$\mathbf{p}_1, \dots, \mathbf{p}_{im}. \tag{26}$$

For example, in the assembly of Fig. 6 the state of self-stress consists of a uniform tension t . Let the product forces be evaluated separately for each of the two mechanisms already determined. By inspection, the product-force vectors are proportional to

$$\begin{bmatrix} 0 & 0 \\ 2 & -1 \\ 0 & 0 \\ -1 & 2 \end{bmatrix}. \tag{27}$$

When each column is multiplied by the product of t and the (small) amplitude of joint displacement, it gives the product-force vector.

Our earlier analysis revealed (Fig. 4) a vector subspace of dimension r_A (the column space of A) of fitted loads which could be carried by the assembly in its original configuration. We can now supplement this with the im-dimensional subspace of product forces, making a $(3j - k)$ by $(3j - k - rb)$ matrix A' , as shown in Fig. 8.

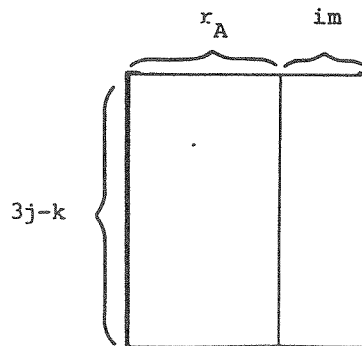

Fig. 8. The general form of A' . The left-hand r_A columns represent the column space of A (Fig. 4, on the right), and the right-hand im columns are the product-force vectors (Section 7) corresponding to the internal inextensional mechanisms. A' is square in the case ($rb = 0$) of assemblies properly constrained to a rigid foundation.

Notice that the new subspace of product forces is quite different in principle from the subspace of forbidden loads revealed by our earlier analysis. That space consists of those loads which *cannot* be carried in the original configuration; but the product forces are those loads which *can* be carried on account of self-stress when the inextensional modes are given small displacements.

It is obvious without any manipulation that the rigid-body motions develop *zero* product forces: the product force at any joint is a consequence of relative rotations of the bars meeting at the joint, which are obviously zero in any rigid-body motion. This is the reason why only product forces corresponding to internal mechanisms need to be assembled in A' .

When $rb = 0$, matrix A' is square; and it follows immediately that there is a possibility that, when we allow the assembly to distort in its inextensional modes, it will be able, after all, to support a completely *arbitrary* set of loads—provided, of course, the amplitudes of the resulting inextensional modes are sufficiently small. This will be the case if the matrix A' is of full rank. For example, the assembly of Fig. 6 has

$$A' = \left[\begin{array}{cc|cc} 1 & -1 & 0 & 0 \\ 0 & 0 & 2 & -1 \\ 0 & 1 & 0 & 0 \\ 0 & 0 & -1 & 2 \end{array} \right], \quad (28)$$

and it is easy to see that

$$\text{rank}(A') = 4; \quad (29)$$

hence this particular arrangement of bars is capable of withstanding arbitrary vertical and horizontal loading at the joints—subject, of course, to the restriction noted above on the amplitude of vertical displacements.

The example of Fig. 6 is, in fact, a primitive sort of cable-net, and it has been shown already[5, 10] that for certain simple types of cable-net having a substantial number of joints, a completely arbitrary pattern of loads may be sustained. We are currently investigating certain problems associated with the computation of the response of cable-nets to arbitrary loads.

In the present paper, however, we shall look in a different direction, at the hypothetical situation in which the product forces, computed as above, all lie *within* the column space of A . In this case the product forces are non-zero, but since they lie within the space of *fitted loads* they do not enable the assembly to carry any loads that it could not carry in its original configuration: the state of self-stress does *not* impart any first-order stiffness to the mechanisms of the assembly.

Figure 2 shows an assembly which has exactly this property. It is a regular four-sided ring on a level rigid base. The 12×12 matrix A is found to have $r_A = 11$, and so

$$m = s = 1. \quad (30)$$

The simple inextensional mechanism involves the upper square distorting into a diamond shape, as shown in Fig. 2(b). It is straightforward to evaluate the product-force vector corresponding to a small displacement of this mechanism and, thus, to assemble the matrix A' . It turns out that $r_{A'} = 11$ and so, unlike the example of Fig. 1(d.1), the state of self-stress does *not* stiffen the assembly against inextensional deformation and, thus, does not enable it to support loading which was forbidden according to the first analysis.

Now it is well known[6] that the ring of Fig. 2 belongs to a class of mechanisms which are free to undergo large displacements. This feature may be verified by ele-

mentary trigonometry; and Tarnai[23] has shown that in general it depends on the presence of a plane of mirror symmetry.

8. FIRST-ORDER INFINITESIMAL MECHANISMS

The example of the ring (Fig. 2) which is *not* stiffened against inextensional deformation by prestress, together with the assembly of Fig. 1(d.1) which *is* stiffened by prestress, illustrate the conjecture of Tarnai, mentioned in Section 1: a state of self-stress imparts first-order stiffness to one mechanism but does not impart any stiffness to another which is already known to be a finite mechanism.

How can we explain the mechanics behind this conjecture, and thereby demonstrate that the conjecture is true?

Consider the assembly of Fig. 6, prestressed and subjected to a load in the direction 2. The assembly provides some stiffness against this loading, as we have seen, because the change in geometry according to the inextensional mechanism enables the prestressed bars to balance an external load. The assembly has some first-order stiffness. Therefore it absorbs some *energy* as the load increases. How is this energy stored? The only possible way in which energy can be stored in the assembly is by the strain-energy associated with a second-order elongation of the bars. In this example it is clear from Pythagoras' theorem that second-order changes of length are needed for the distortion of this mechanism. It is also clear that this type of second-order stretching will in general tend to increase the level of prestress in the assembly, so that the relationship between transverse load and transverse deflection will in general be nonlinear: it is only linear—as revealed by the product-force calculation—for sufficiently small deflections. When the assembly is prestressed, the transverse displacement which gives, geometrically, second-order changes in length of the bars also gives a second-order change in the strain energy of the bars, and thus imparts the first-order stiffness which is detected by the matrix method of Section 7.

What all of this amounts to is that any first-order stiffness which a state of self-stress imparts to an inextensional mechanism may be taken as evidence that the geometry of distortion in fact requires second-order changes of lengths in the bars. Hence, if no first-order stiffness is detected by our method, then the inextensional mechanism is either a second- or higher-order infinitesimal mechanism or a finite mechanism. Tarnai's conjecture is thus confirmed. We can also see that the order of the stiffening which is imparted to an infinitesimal mechanism by prestress is directly related to the order of changes of length in the bars; which provides an answer to Tarnai's first question.

If the product-force vector does not lie in the column space of A , then the corresponding mechanism is infinitesimal, of first order. But if it does lie in the column space, we cannot distinguish between a higher-order infinitesimal mechanism and a finite mechanism. This provides both an answer to Tarnai's second question and also a qualification of it.

If a given assembly has $m > 0$ and $s = 0$, the product-force vectors are necessarily zero, and therefore the corresponding mechanisms are not infinitesimal of first order. Examples of this kind which are finite mechanisms [e.g. Fig. 1(b)] are well known.

As a further example we consider a small version of a tetrahedral-octahedral truss, shown in Fig. 9. This truss has two equal square grids lying in horizontal planes, with the joints of one grid vertically aligned with the centres of the squares of the other. Each joint is connected by bars to the four nearest neighbours of the other grid. Figure 9 shows the smallest possible version of this truss, with two squares in each grid.

The truss satisfies Maxwell's rule for a rigid assembly which is free in space; substitution of $b = 30$, $j = 12$ in (10) gives

$$s - m = -6. \quad (31)$$

Therefore, if $s = 0$, $m = 6$, corresponding to the rigid-body motions. But Crapo[24]

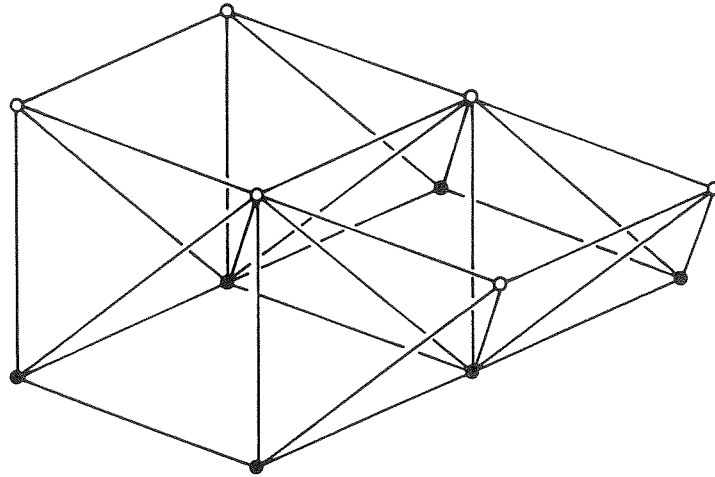

Fig. 9. Perspective sketch of tetrahedral-octahedral truss. The joints at the lower level are shown black.

shows, correctly, that $im = 1$, and he also states, without proof, that the mechanism is not finite.

We have subjected this assembly to the present scheme of analysis, by means of our computer program, and with the following results:

$$r_A = \text{rank}(A) = 29,$$

so

$$s = b - r_A = 1 \quad (32)$$

and

$$m = 3j - r_A = 7.$$

Also,

$$rb = 6,$$

so

$$im = m - rb = 1. \quad (33)$$

The assembly thus has one state of self-stress and one internal mechanism in addition to six rigid-body motions. The matrix A' , found by compounding the column space of A (29 columns) and the product-force vector (one column) is found to have $\text{rank}(A') = 30$; therefore the internal mechanism is a second-order infinitesimal one. In a more complicated example having $s > 1$, it would be necessary to assemble A' and determine its rank for each independent state of self-stress.

9. DISCUSSION

We have succeeded in giving a matrix test for a first-order infinitesimal mechanism, as distinct from a higher-order or a finite one. We believe that the test is generally valid, provided we take into account one further point, concerning the stability of equilibrium, as follows.

Consider again the assembly of Fig. 6. If we envisage the bars as elastic and



Fig. 10. Example of Kuznetsov[26], related to the assembly of Fig. 6, but which has different properties.

introduce a state of *compressive* self-stress by lengthening slightly one of the bars, the assembly thereby becomes loose in a way which we would normally describe by

$$s = 0, \quad m = 1 \quad (34)$$

instead of having $s = 1, m = 2$ for the assembly as shown and as discussed previously.

In Section 8 we described how an assembly absorbs energy by second-order elastic elongations of the bars. The assembly is stable only if the strain energy increases for every mode[25]. We can detect positive stiffness in first-order infinitesimal mechanisms by our matrix method through an examination of the *sign* of the scalar product of the nodal displacements of a mechanism and the corresponding product-force vector. In our example of Fig. 6, this scalar product has the same sign for both mechanisms, and so a change to compressive prestress makes both mechanisms unstable. Kuznetsov[26] has an example, shown in Fig. 10, which is a variant of our Fig. 6 and also has $s = 1, m = 2$, but in which the scalar product of the mechanisms and the corresponding product forces are of opposite sign. This implies that one of the two mechanisms is unstable whatever the sign of the prestress: and in fact the assembly is free to distort as a four-bar chain.

It is thus clear that our matrix test of Section 7 for first-order stiffness must be supplemented in general by a check that the scalar product of *all* mechanisms with the corresponding product forces are positive.

It is interesting to note that Maxwell was aware of special cases such as frameworks which satisfied his rule but had both $s > 0, m > 0$ [4]. He associated these loosely with conditions of maximum or minimum length. A cable-net of the kind studied in [5, 10] provides a nice example of this. It is generally loose, with $s = 0$, but it becomes tight, with $s = 1$ when the members are steadily shortened. The change in behaviour occurs precisely when the members are so short that they could not be connected at all (in the absence of elastic stretching) if they were made any shorter—a clear case of minimum length. It is precisely the fact that the total length of members is minimum initially and can thus only increase under any pattern of distortion, which generally makes the level of prestress increase as the assembly distorts.

The case illustrated in Fig. 2 also satisfies Maxwell's rule and also has $s = 1 > 0, m = 1 > 0$. It can distort freely as a mechanism, with absolutely no change in length of its members. As we have already seen in Section 7, the product-force vector for the self-stressed assembly lies in the column space of the equilibrium matrix: self-stress imparts no first-order stiffness to the assembly. This assembly is evidently of a type not envisaged by Maxwell: its key feature is one of symmetry (see Section 7) rather than of maximum or minimum length. Our matrix test successfully detects the absence of first-order stiffening due to prestress. In cases like this, the mechanism may in fact be a finite one; and it would be sensible to search for matters of symmetry, etc. by *ad hoc* methods.

Acknowledgements—We thank Prof. J. Heyman, Dr R. K. Livesley and Dr J. M. Prentis for continuing help; and Dr M. Braestrup, Prof. W. T. Koiter, Prof. G. Strang and Dr T. Tarnai for comments on an earlier version which was presented at the 16th IUTAM Congress in Lyngby, Denmark, August 1984. We are also grateful to one of the referees for pointing out reference [26] to us.

REFERENCES

1. N. J. Hoff and J. Fernandez-Sintes, Kinematically unstable space frameworks. In *Mechanics Today* (Edited by S. Nemat-Nasser), Vol. 5, Chap. 7. Pergamon Press, Oxford (1980).
2. E. W. Parkes, *Braced Frameworks*, 2nd Edn. Pergamon Press, Oxford (1974).

3. S. P. Timoshenko and D. H. Young, *Theory of Structures*. 2nd Edn. McGraw-Hill, New York (1965).
4. C. R. Calladine, Buckminster Fuller's 'Tensegrity' structures and Clerk Maxwell's rules for the construction of stiff frames. *Int. J. Solids Struct.* **14**, 161-172 (1978).
5. C. R. Calladine, Modal stiffnesses of a pretensioned cable net. *Int. J. Solids Struct.* **18**, 829-846 (1982).
6. T. Tarnai, Simultaneous static and kinematic indeterminacy of space trusses with cyclic symmetry. *Int. J. Solids Struct.* **16**, 347-359 (1980).
7. O. Vilnay, Determinate tensegric shells. *ASCE J. Struct. Div.* **107**, 2029-2033 (1981).
8. O. Vilnay and S. S. Soh, Tensegric shell behaviour. *ASCE J. Struct. Div.* **108**, 1831-1845 (1982).
9. G. Strang, *Linear Algebra and Its Applications*. 2nd Edn., Chap. 2. Academic Press, New York (1980).
10. S. Pellegrino and C. R. Calladine, Two-step matrix analysis of prestressed cable nets. In *Proc. Third Int. Conf. Space Structures*, Guildford. Elsevier Applied Science, London (1984).
11. T. Tarnai, Problems concerning spherical polyhedra and structural rigidity. *Struct. Topology* **4**, 61-66 (1980).
12. W. T. Koiter, *On Tarnai's conjecture with reference to both statically and kinematically indeterminate structures*. Report No. 788 of Laboratory for Engineering Mechanics, Delft (1984).
13. R. K. Livesley, *Matrix Methods of Structural Analysis*. 2nd Edn. Pergamon Press, Oxford (1975).
14. J. Ll. Morris, *Computational Methods in Elementary Numerical Analysis*. Wiley, Chichester (1983).
15. J. S. Robinson, *Structural Matrix Analysis for the Engineer*. Wiley, New York (1966).
16. J. S. Przemieniecki, *Theory of Matrix Structural Analysis*. McGraw-Hill, New York (1968).
17. W. McGuire and R. H. Gallagher, *Matrix Structural Analysis*. Wiley, New York (1979).
18. R. K. Livesley, Linear programming in structural analysis and design. In *Optimum Structural Design* (Edited by R. H. Gallagher and O. C. Zienkiewicz), Chap. 6. Wiley, London (1973).
19. H. A. Buchholdt, M. Davies and M. J. L. Hussey, The analysis of cable nets. *J. Inst. Math. Appl.* **4**, 339-358 (1968).
20. H. Crapo, Structural rigidity. *Struct. Topology* **1**, 26-45 (1979).
21. E. D. Bolker and B. Roth, When is a bipartite graph a rigid framework? *Pacific J. Math.* **90**, 27-44 (1980).
22. W. Whiteley, Motions of trusses and bipartite frameworks. *Struct. Topology* **7**, 61-68 (1982).
23. T. Tarnai, Finite mechanisms and the octagon of Ely cathedral. *Struct. Topology* (1986), in press.
24. H. Crapo, The octahedral-tetrahedral truss. *Struct. Topology* **6**, 52-61 (1982).
25. J. M. T. Thompson and G. W. Hunt, *Elastic Instability Phenomena*. Wiley, Chichester (1984).
26. E. N. Kuznetsov, Statical-kinematic analysis and limit equilibrium of systems with unilateral constraints. *Int. J. Solids Struct.* **15**, 761-767 (1979).

APPENDIX TRANSFORMATION OF COLUMN j OF A

In the following description $i - 1$ pivots have been found in previous stages of the elimination: therefore the first $i - 1$ rows and $j - 1$ columns of A have to be disregarded.

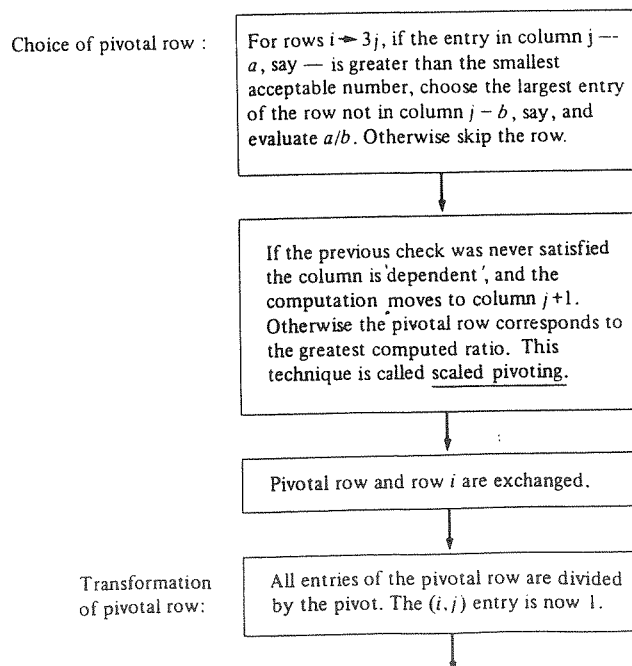

Transformation of
entries below pivot:

↓

For rows $i \rightarrow 3j - k$, if the entry below
the pivot is smaller than smallest
acceptable number, skip the row.
If the row can be considered proportional
to the pivotal row, set all its entries
equal to zero.
Otherwise subtract the entry below
the pivot multiplied by the pivotal row.